



KID'S MENU



CHICKEN TENDERS

Served with French Fries, 10

CHEESEBURGER

Served with French Fries, 11

CHEESE PIZZA

10

TOASTED RAVIOLI

Served with Marinara Sauce
and French Fries, 11

MOZZARELLA STICKS

Served with Marinara Sauce
and French Fries, 10

APPLESAUCE

2.50

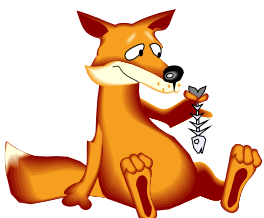

MAY SUBSTITUTE APPLESAUCE IN PLACE OF FRENCH FRIES

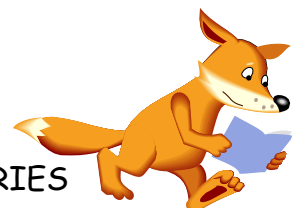

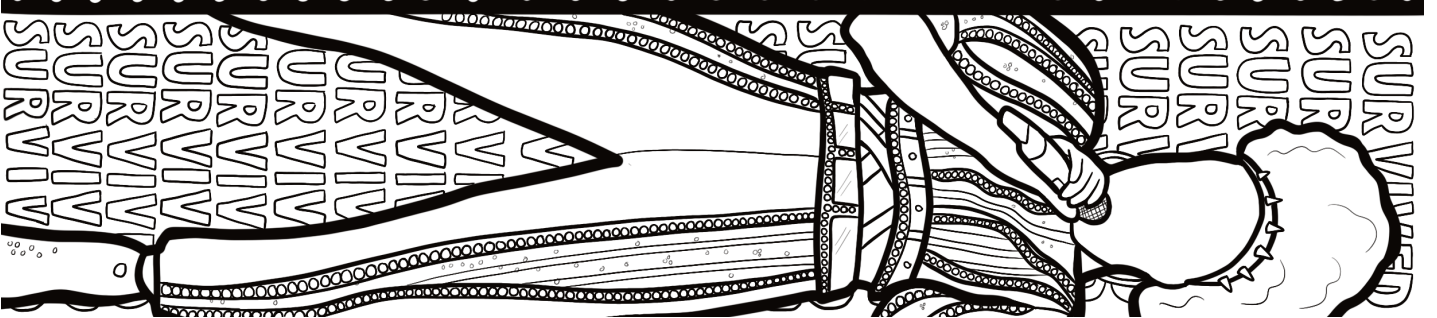
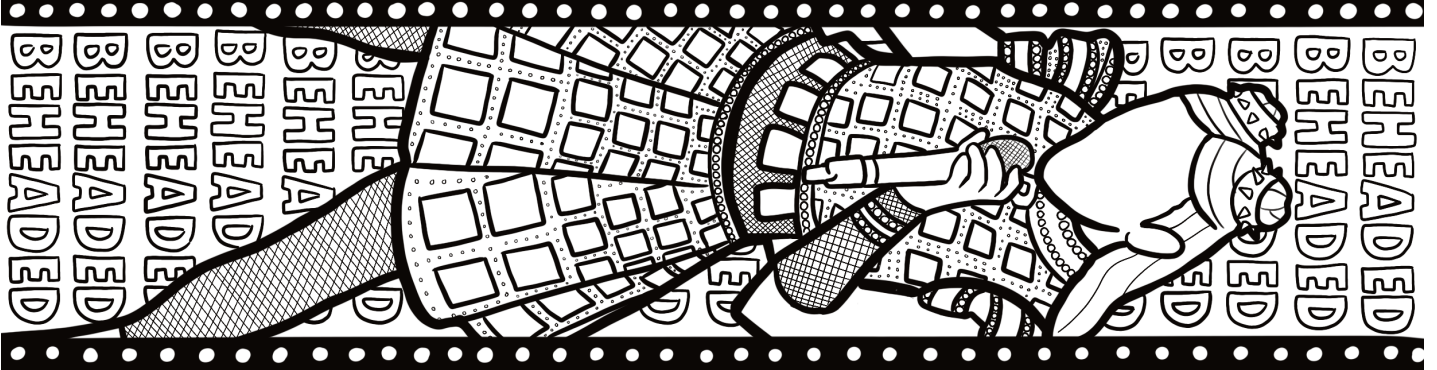



KID'S MENU



CHICKEN TENDERS

Served with French Fries, 10

CHEESEBURGER

Served with French Fries, 11

CHEESE PIZZA

10

TOASTED RAVIOLI

Served with Marinara Sauce
and French Fries, 11

MOZZARELLA STICKS

Served with Marinara Sauce
and French Fries, 10

APPLESAUCE

2.50

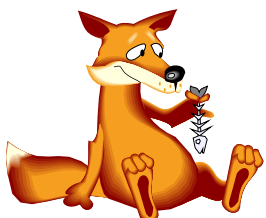

MAY SUBSTITUTE APPLESAUCE IN PLACE OF FRENCH FRIES



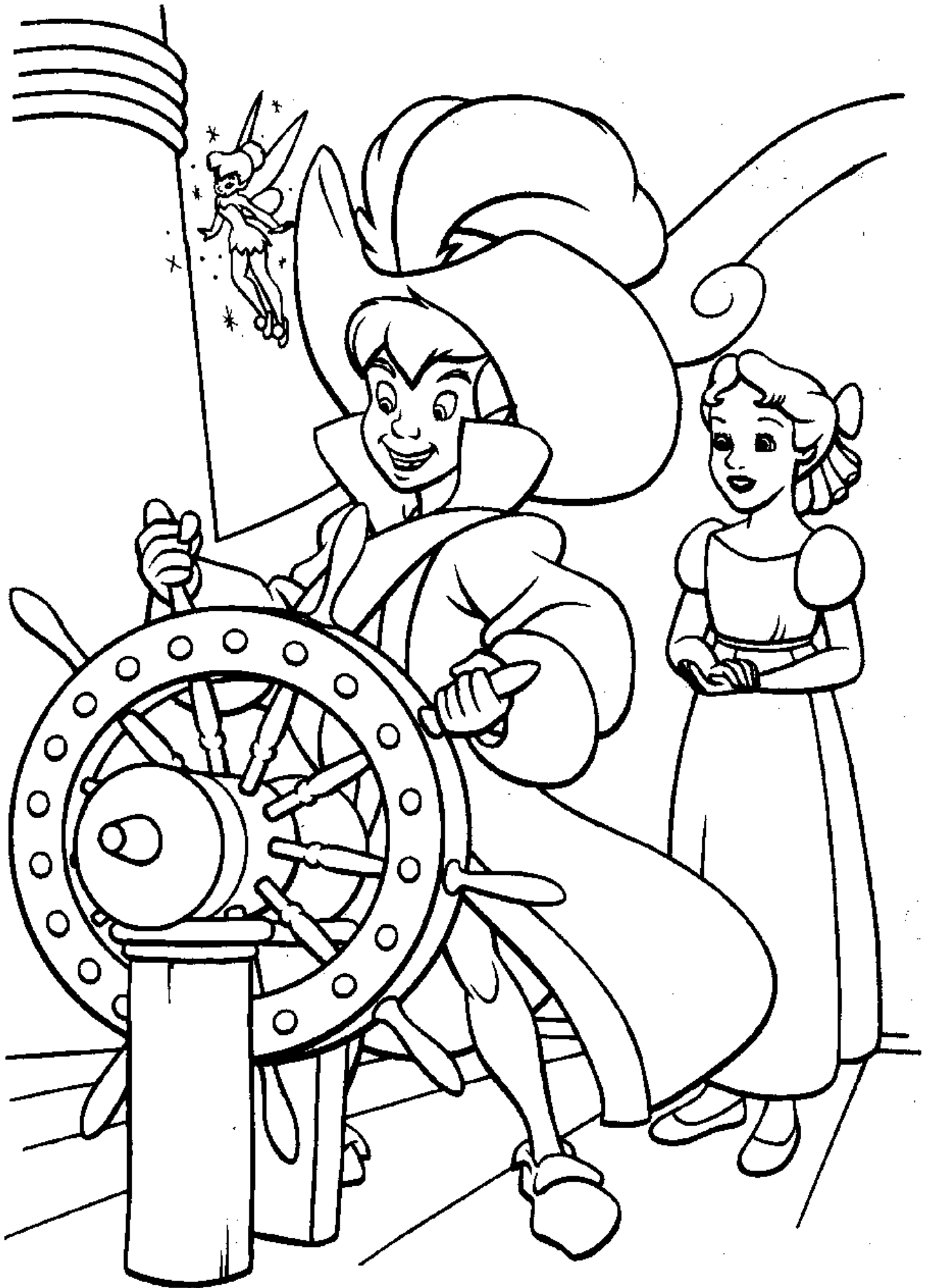



KID'S MENU



CHICKEN TENDERS

Served with French Fries, 10

CHEESEBURGER

Served with French Fries, 11

CHEESE PIZZA

10

TOASTED RAVIOLI

Served with Marinara Sauce
and French Fries, 11

MOZZARELLA STICKS

Served with Marinara Sauce
and French Fries, 10

APPLESAUCE

2.50

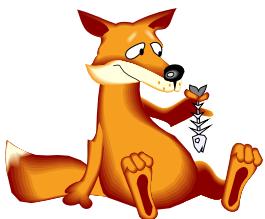

MAY SUBSTITUTE APPLESAUCE IN PLACE OF FRENCH FRIES



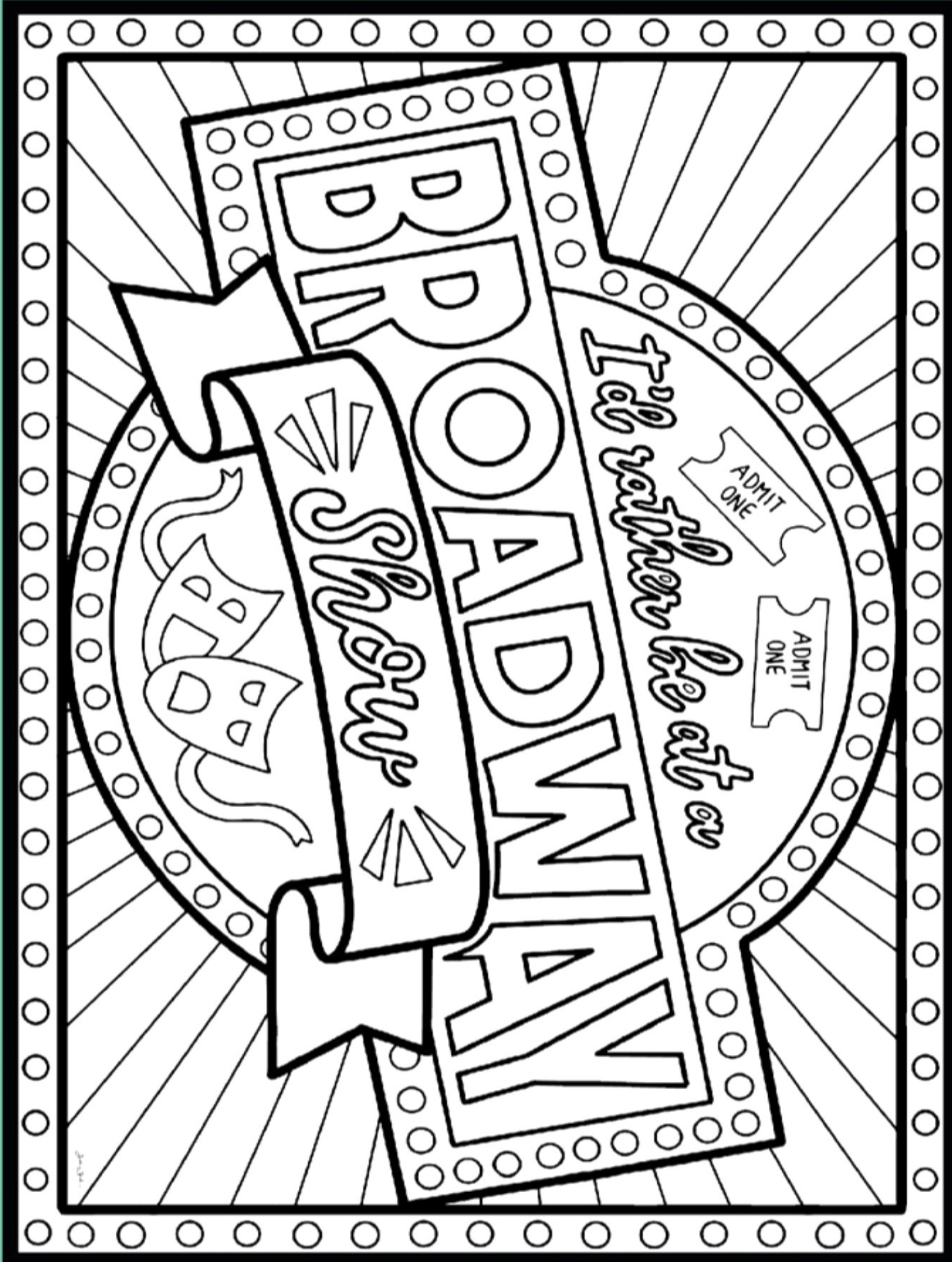



KID'S MENU



CHICKEN TENDERS

Served with French Fries, 10

CHEESEBURGER

Served with French Fries, 11

CHEESE PIZZA

10

TOASTED RAVIOLI

Served with Marinara Sauce
and French Fries, 11

MOZZARELLA STICKS

Served with Marinara Sauce
and French Fries, 10

APPLESAUCE

2.50

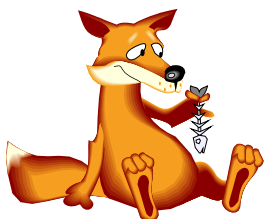

MAY SUBSTITUTE APPLESAUCE IN PLACE OF FRENCH FRIES



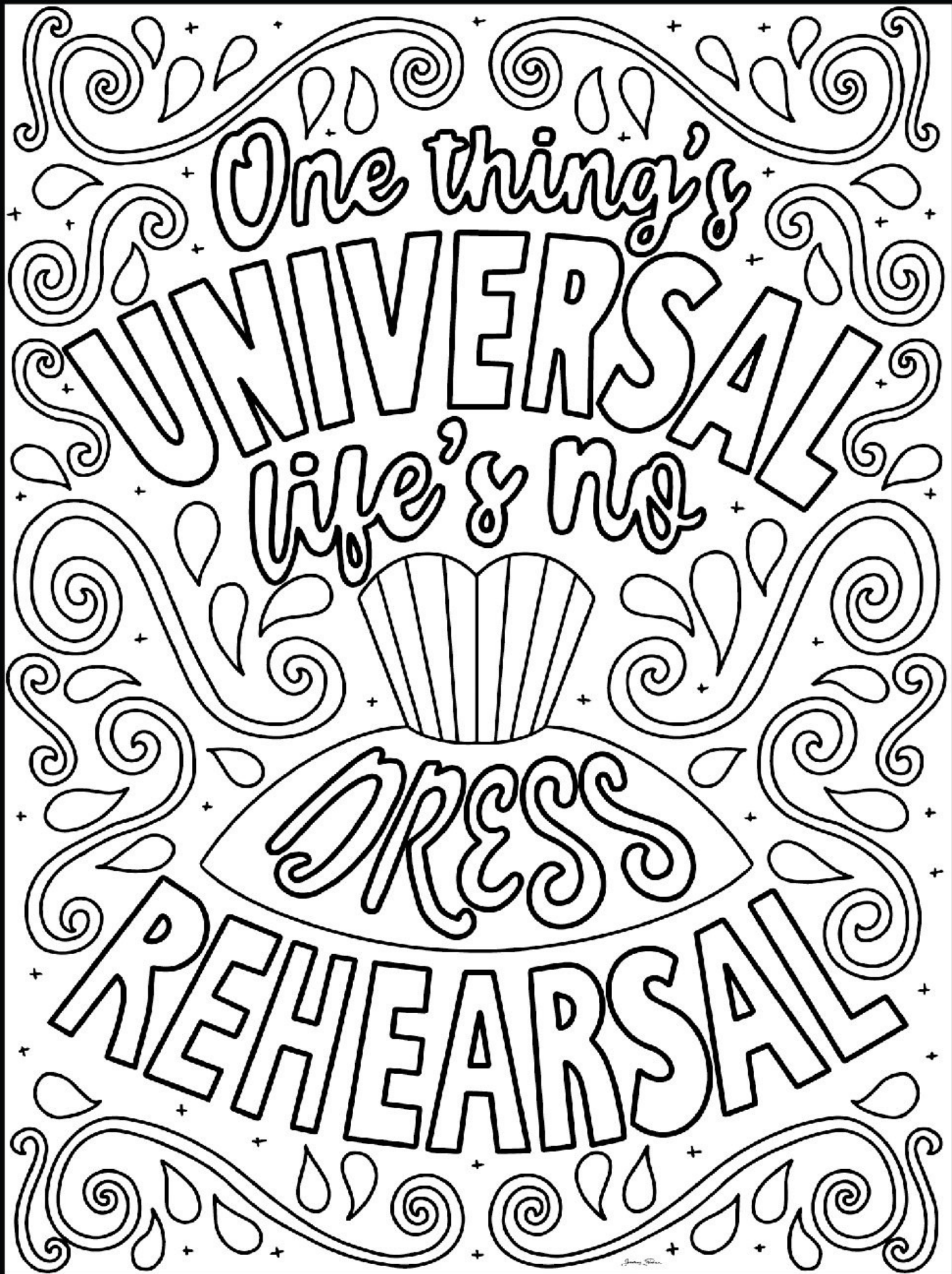

One thing's

UNIVERSAL

life's no

DRESS

REHEARSAL



KID'S MENU



CHICKEN TENDERS

Served with French Fries, 10

CHEESEBURGER

Served with French Fries, 11

CHEESE PIZZA

10

TOASTED RAVIOLI

Served with Marinara Sauce
and French Fries, 11

MOZZARELLA STICKS

Served with Marinara Sauce
and French Fries, 10

APPLESAUCE

2.50

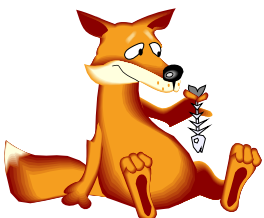

MAY SUBSTITUTE APPLESAUCE IN PLACE OF FRENCH FRIES



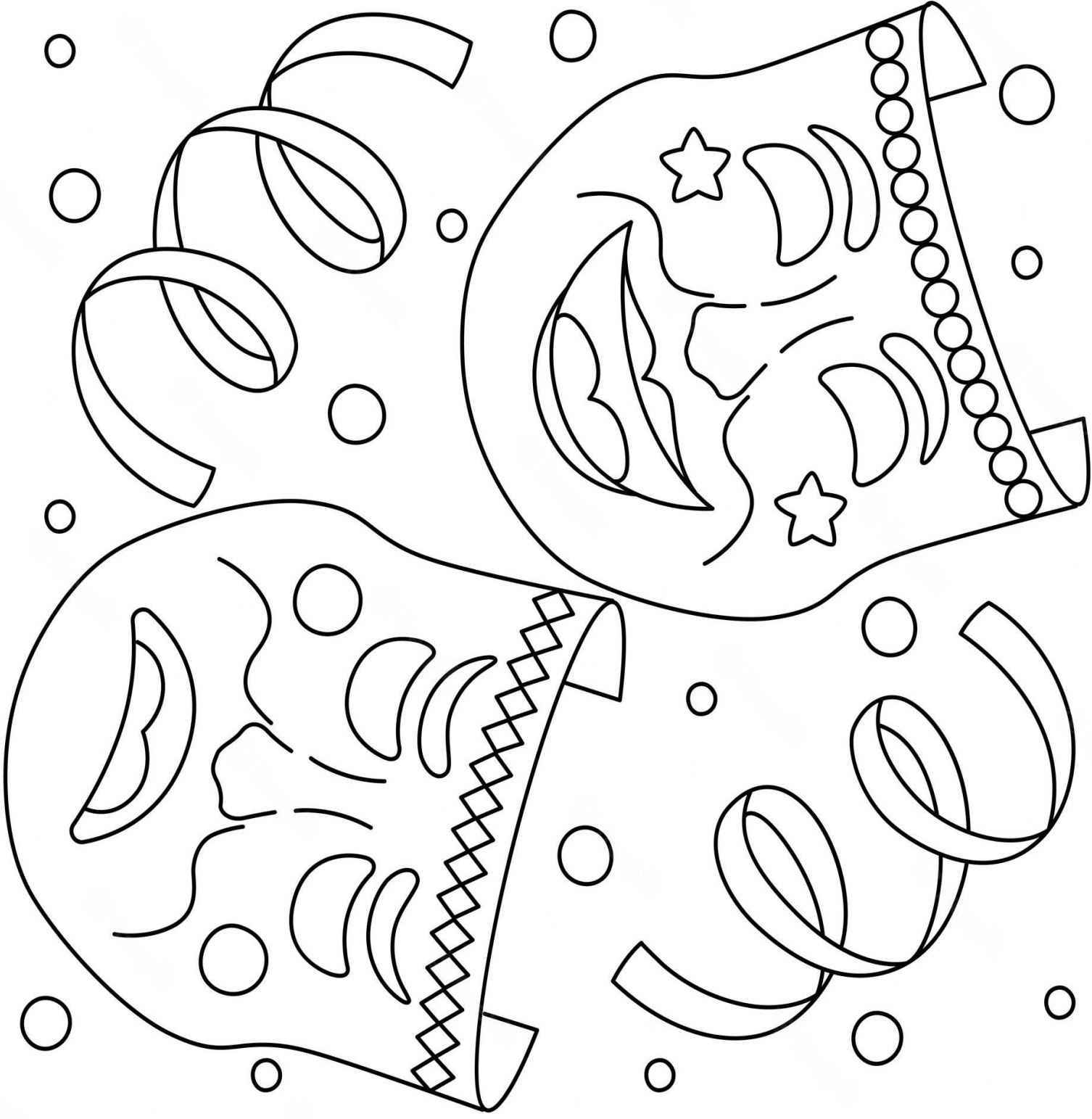



KID'S MENU



CHICKEN TENDERS

Served with French Fries, 10

CHEESEBURGER

Served with French Fries, 11

CHEESE PIZZA

10

TOASTED RAVIOLI

Served with Marinara Sauce
and French Fries, 11

MOZZARELLA STICKS

Served with Marinara Sauce
and French Fries, 10

APPLESAUCE

2.50

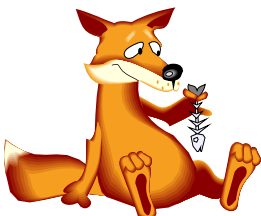

MAY SUBSTITUTE APPLESAUCE IN PLACE OF FRENCH FRIES



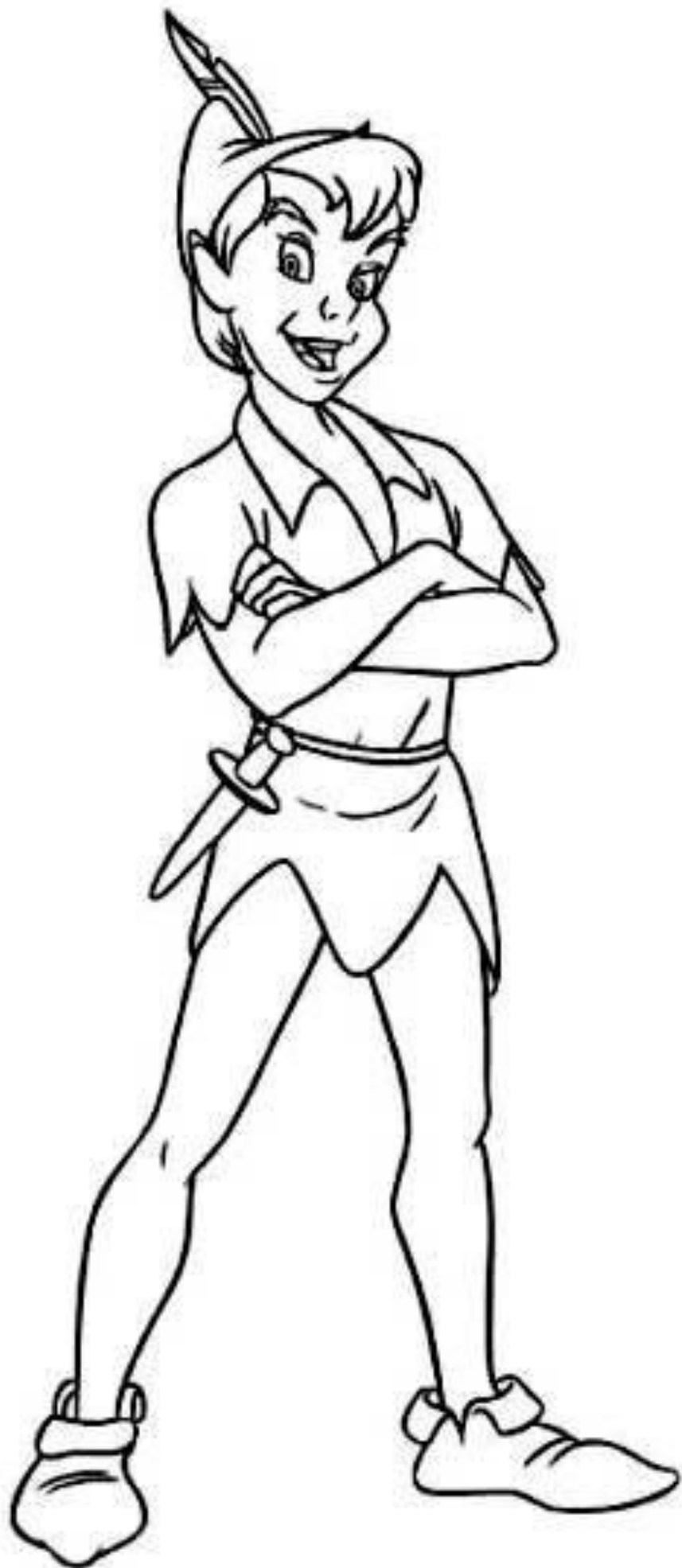



KID'S MENU



CHICKEN TENDERS

Served with French Fries, 10

CHEESEBURGER

Served with French Fries, 11

CHEESE PIZZA

10

TOASTED RAVIOLI

Served with Marinara Sauce
and French Fries, 11

MOZZARELLA STICKS

Served with Marinara Sauce
and French Fries, 10

APPLESAUCE

2.50

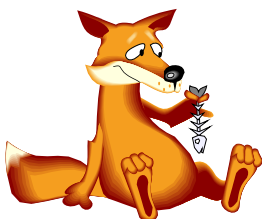

MAY SUBSTITUTE APPLESAUCE IN PLACE OF FRENCH FRIES



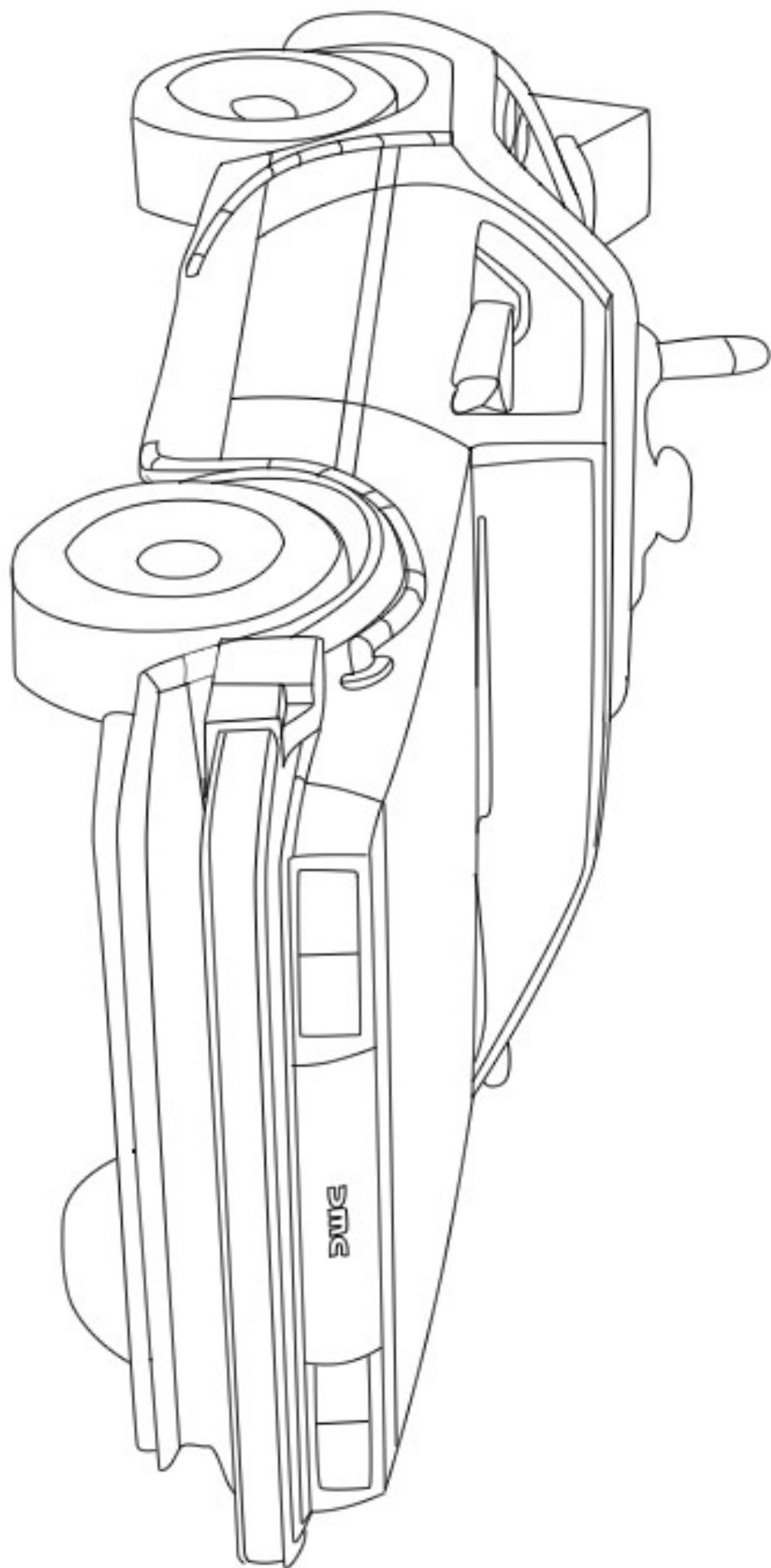



KID'S MENU



CHICKEN TENDERS

Served with French Fries, 10

CHEESEBURGER

Served with French Fries, 11

CHEESE PIZZA

10

TOASTED RAVIOLI

Served with Marinara Sauce
and French Fries, 11

MOZZARELLA STICKS

Served with Marinara Sauce
and French Fries, 10

APPLESAUCE

2.50

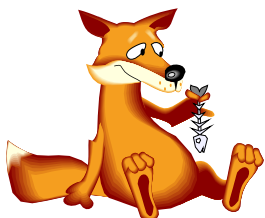

MAY SUBSTITUTE APPLESAUCE IN PLACE OF FRENCH FRIES



Broadway Musicals

WORD SEARCH PUZZLE

M L E S M I S E R A B L E S M J Z M K
A H A I R S P R A Y H T E C I X C A U
R K T O H D W C W X E N J D S W M N Y
Y I B W U A G Q U I A B E V S O C O A
P N I V K T H E O S C U R G S T A F L
O K L A H O M A L Y H K S R A F B L Y
P Y O I O L Y R D U O D E X I H A A I
P B F T Y W I A I C R C Y D G H R M M
I O Q N G G L V Z G U Z B J O A E A A
N O U A M R R L N D S X O I N M T N M
S T X A I G K K O Q L Y Y O F I I C M
G S E A Z V H R J U I T S E N L Z H A
W R F X Q Q P P R W N P D I V T I A M
D Y E P P E U H D Q E J D J G O I L I
M K V A H I P X J L N D B O T N A C A
C X I T S O U T H P A C I F I C Y I E
H M T H Z E W K A L C H I C A G O E U
S P A M A L O T A R O C K O F A G E S
T H E L I O N K I N G U C A Z S A Y B

A CHORUS LINE

ALADDIN

CABARET

CHICAGO

DREAMGIRLS

EVITA

GREASE

HAIRSPRAY

HAMILTON

JERSEY BOYS

KINKY BOOTS

LES MISERABLES

MAMMA MIA

MAN OF LA MANCHA

MARY POPPINS

MISS SAIGON

MY FAIR LADY

OKLAHOMA

ROCK OF AGES

SOUTH PACIFIC

SPAMALOT

THE LION KING

THE PRODUCERS

WICKED



KID'S MENU



CHICKEN TENDERS

Served with French Fries, 10

CHEESEBURGER

Served with French Fries, 11

CHEESE PIZZA

10

TOASTED RAVIOLI

Served with Marinara Sauce
and French Fries, 11

MOZZARELLA STICKS

Served with Marinara Sauce
and French Fries, 10

APPLESAUCE

2.50

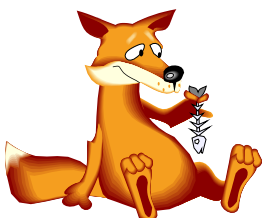

MAY SUBSTITUTE APPLESAUCE IN PLACE OF FRENCH FRIES







KID'S MENU



CHICKEN TENDERS

Served with French Fries, 10

CHEESEBURGER

Served with French Fries, 11

CHEESE PIZZA

10

TOASTED RAVIOLI

Served with Marinara Sauce
and French Fries, 11

MOZZARELLA STICKS

Served with Marinara Sauce
and French Fries, 10

APPLESAUCE

2.50

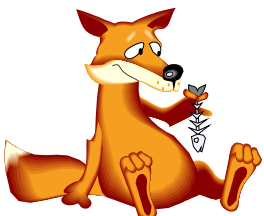

MAY SUBSTITUTE APPLESAUCE IN PLACE OF FRENCH FRIES



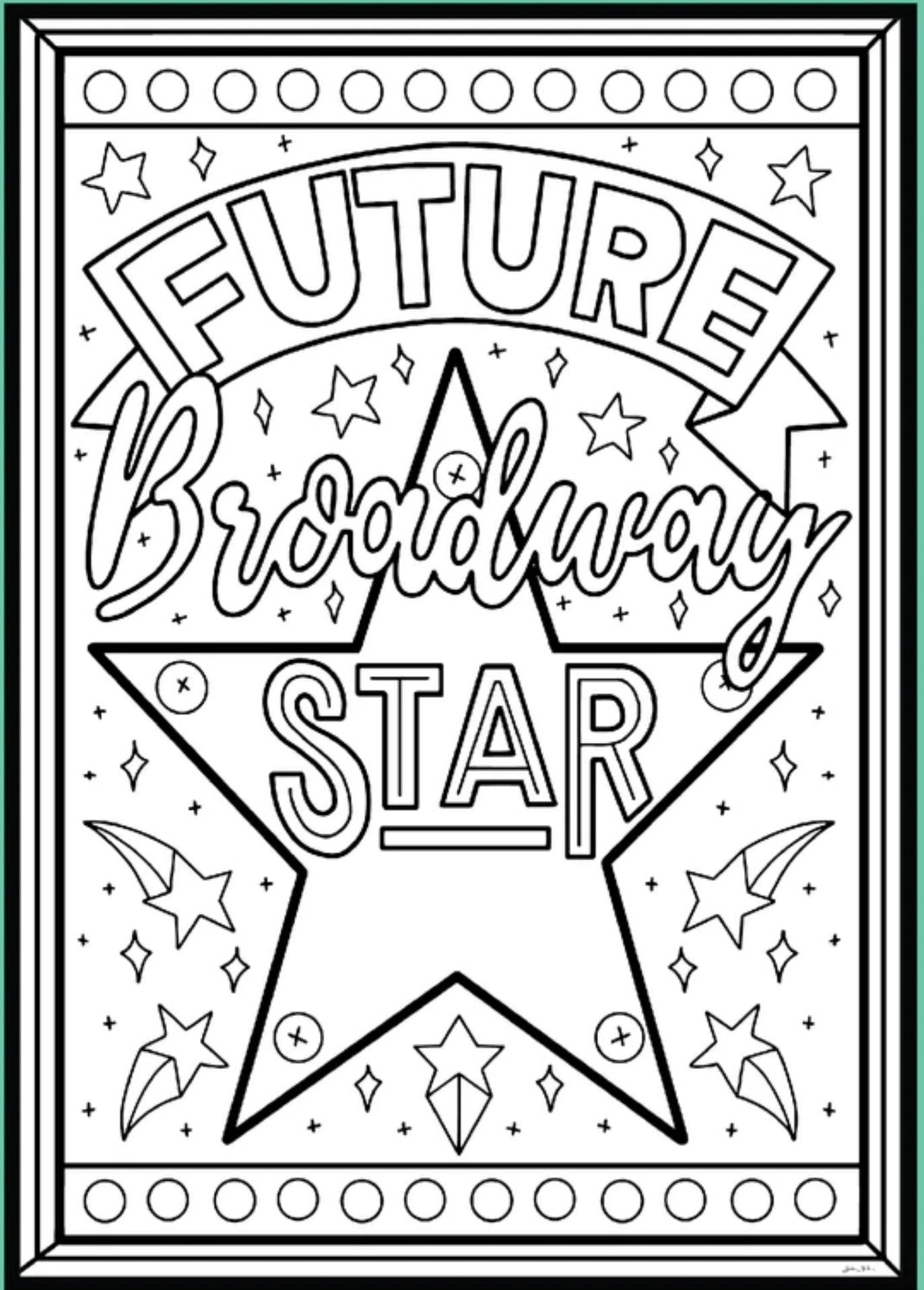

FUTURE

Broadway

STAR

